

9M CONIC ROTUND

Model : PLG9M
HOT DIP GALVANIZED POLE

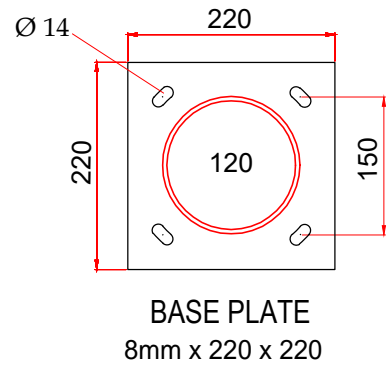
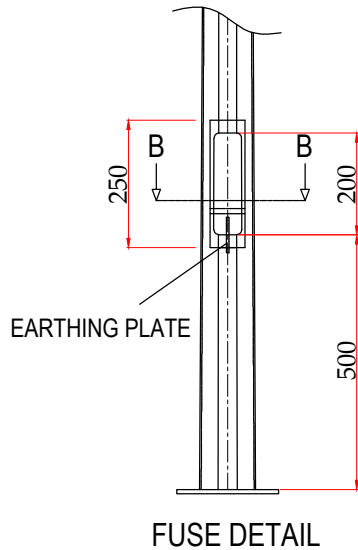
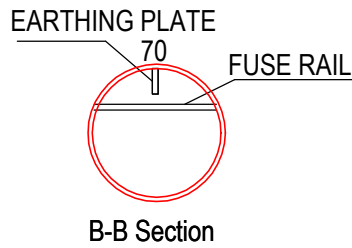
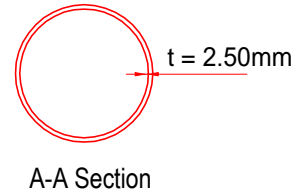
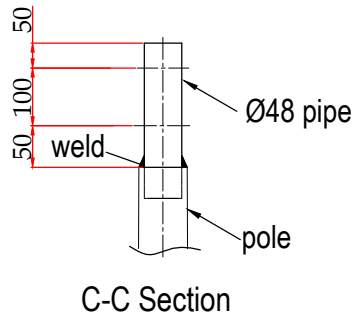
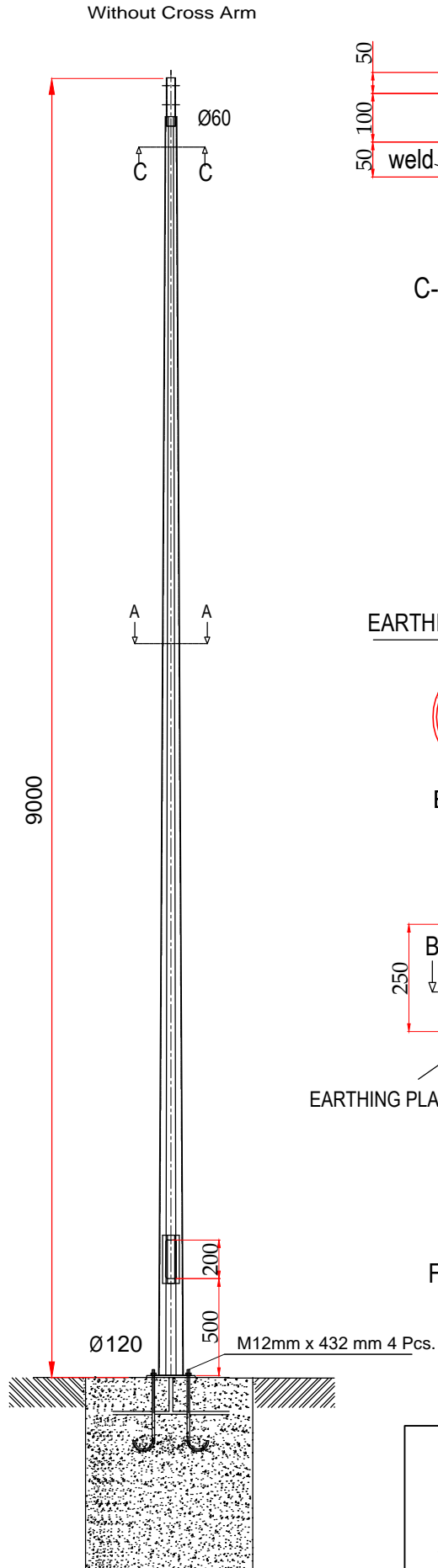

NOTA: TOTI STALPII SE POT PERSONALIZA IN
FUNCTIE DE CERINTELE PROIECTULUI

Plate Standard : EN 10025
Production Standard : EN 40-5
Galvanizing Standard : EN 1461

URBIO PALAGIO SRL
Str 1 Decembrie, nr 14, Selimbar, Jud Sibiu

ST-O.9M. Model:PLG9M

without Cross Arm

Steel : S235 S235JR (ST37)

www.palagio.ro

Rev : 1