

# 10M CONIC ROTUND

Model : PLG10M  
HOT DIP GALVANIZED POLE

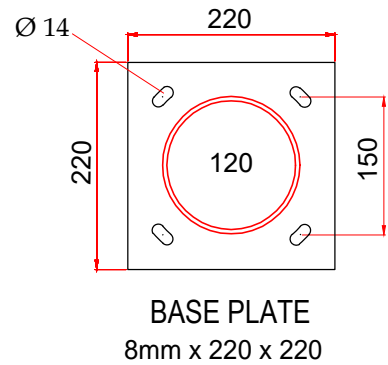
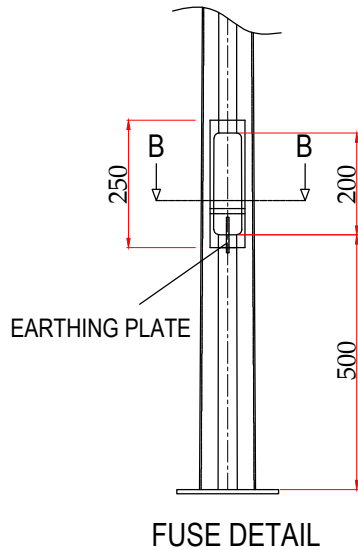
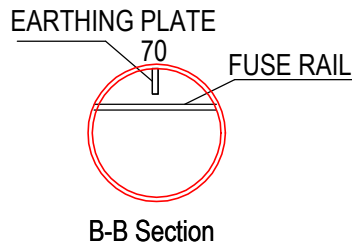
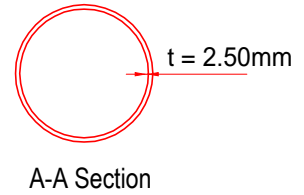
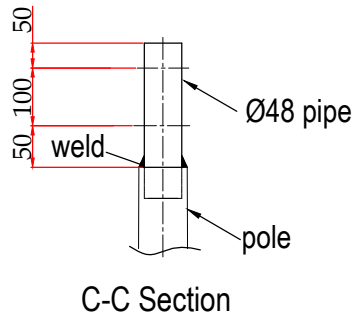
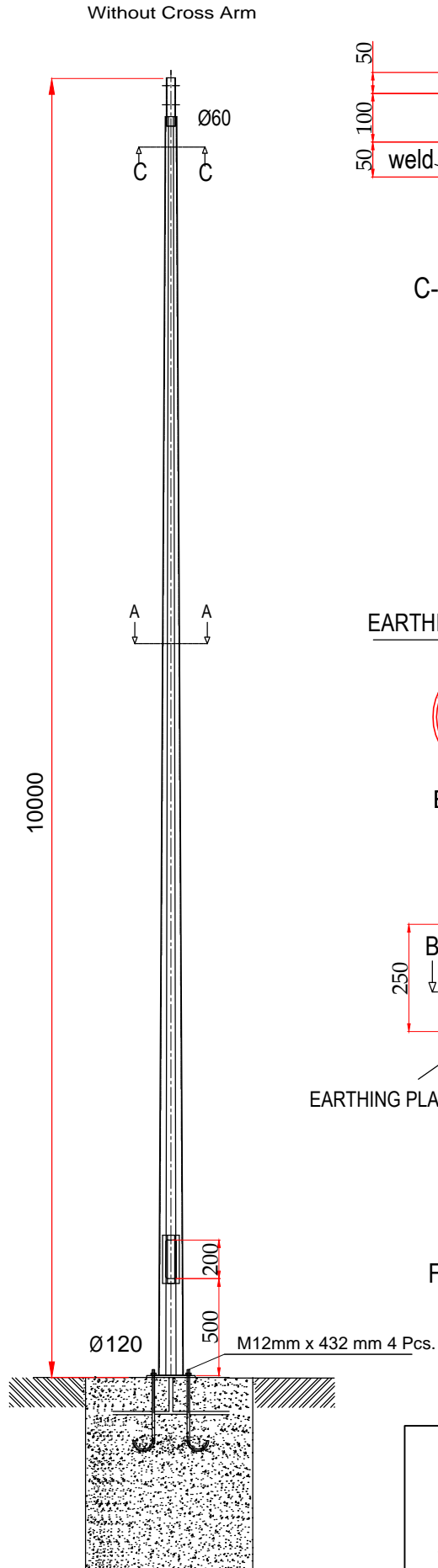

NOTA: TOTI STALPII SE POT PERSONALIZA IN  
FUNCTIE DE CERINTELE PROIECTULUI

Plate Standard : EN 10025  
Production Standard : EN 40-5  
Galvanizing Standard : EN 1461

**URBIO PALAGIO SRL**  
Str 1 Decembrie, nr 14, Selimbar, Jud Sibiu

ST-O.10M. Model:PLG10M

without Cross Arm

Steel : S235 S235JR (ST37)

www.palagio.ro

Rev : 1